

HYDRAULIC CYLINDERS



- BACKSTAY ADJUSTER • CONTROL PANEL • VANG
- HALYARD TENSIONER • MAST-JACK • OUTHAUL



Fast and convenient adjustment of the main trim functions is vital both for the racing sailor and for the cruising sailor. Just being able to tension the forestay and adjust the halyard tension and outhaul will make any boat point higher, sail faster and under better control. Seldén has developed a range of hydraulic cylinders that are easy to use and of a quality that ensures long service life. The rods are marine grade stainless steel and the cylinders black anodized or clear anodized aluminium. The tensioners have long stroke making it possible to try out different mast rakes. The control panels are available for single function or 4-functions and feature an adjustable relief valve to prevent overload.



A 2-speed function permits fast tensioning until a pre-set pressure is obtained. Then the panel shifts down to low speed and reduced resistance in the handle. The level of pressure needed to gear down is easily adjusted to suit the individual trimmer. "Dual Action" means the pump is active both when pushing and when pulling the handle. Releasing the pressure is done by twisting the control of the release valve. The panels can be connected to an electric pump station that replaces manual pumping with the push of a button. Choose between a black anodized panel or clear anodized aluminium.

Manual hydraulics

Manual hydraulics is exactly what it sounds like. The pumping is done by hand and oil flow in a closed system and makes the cylinders work. The closed system can be more or less extensive depending which functions you want to handle with the help of hydraulics.

Here is a guide to help you find everything for your installation.

Backstay adjuster, model HTI

"HTI" stands for "Hydraulic Tensioner Integral" and means that the closed hydraulic system is completely integrated into the cylinder and the pump handle is on the product itself. For this tensioner, nothing more is needed. Just choose the right size and suitable connection for your backstay. You may need to adjust the length of your backstay wire. Check that the clevis pin at the lower end of the tensioner fits your chainplate. See page 13.

Backstay adjuster HT, Hydraulic Vang, Hydraulic halyard tensioner

These functions are connected to a control panel permanently mounted in the cockpit. The control panel consists of a manual pump, a needle valve that releases the pressure and a selector valve with which you decide which function you want to activate. The pump draws oil from a tank and delivers it at high pressure to the cylinder. When the pressure is released, the cylinder is emptied and the oil returns to the tank. The closed system thus consists of a low pressure side between tank and control panel and a high pressure side between control panel and cylinder.

Mast-jack

The mast jack system consists of a hydraulic cylinder piston that moves down vertically through the heel of the mast, thereby lifting the mast and increasing the rig tension. It also lets you relieve the load on the rig and boat when you are in port.

The "jack" is completely integrated in the keelstepped mast and temporarily connected to a two-stage pump that switches to its lower gear as the pressure increases. When the mast reaches its upper position, shims are placed between the heel and the T-base. Thereafter the pressure is released and the pump removed. Now, the rig is set in accordance with the predetermined requirements. So is the boom height, I-measurement and other rating measurements recorded by the measuring official.

The hydraulic hose is stored in a purpose-designed hose garage to keep it out of the way when not used and the hose garage itself is fitted inside the mast. The T-base can be adjusted in fore and aft direction to obtain the optimal mast rake and pre-bend.

The easiest way to get this function is to specify it when buying a new mast or a new boat.

Hydraulic outhaul tensioner

Hydraulic outhaul control is available for the larger Seldén boom sections. The hose from the cylinder is connected to a gland at the mast from which a high-pressure hose connects to the control panel. An outhaul cylinder is seldom retrofitted but specified prior to production of the boom.

Electric motor instead of manual pumping

Manual pumping on the control panel can be replaced with an electric pump (12/24V) which is mounted between the tank and control panel.



Control panel, 4-functions



Hydraulic backstay tensioner (HT), operated from a control panel



Mast-jack

Follow these steps to find the correct parts

1. Do you want to be able to manage more than one function? In that case, you choose the panel that handles up to four functions.
2. Choose between a clear anodized (silver) or black panel.
3. Do you want one or two panels? One point of having two panels is to be able to maneuver the hydraulic functions from each side of the cockpit as opposed to moving down to lee beam just to adjust the trim.
4. Choose the right oil reservoir. Two sizes of reservoirs are available and which one you choose depends on the total volume of the cylinders.
5. Determine the required length of the low-pressure hoses, ie the hoses between the tank and the control panel. You will find part numbers for different lengths on the page 8. Two hoses are needed.
6. Determine which coupling kit you need depending on the number of control panels. See page 8.
7. Determine the length of the high-pressure hose for each function. The function decides which angle of the terminals is needed. Go to page 9 and make your choice.
8. For a high-pressure hose passing through deck a deck-gland is available. See page 10.

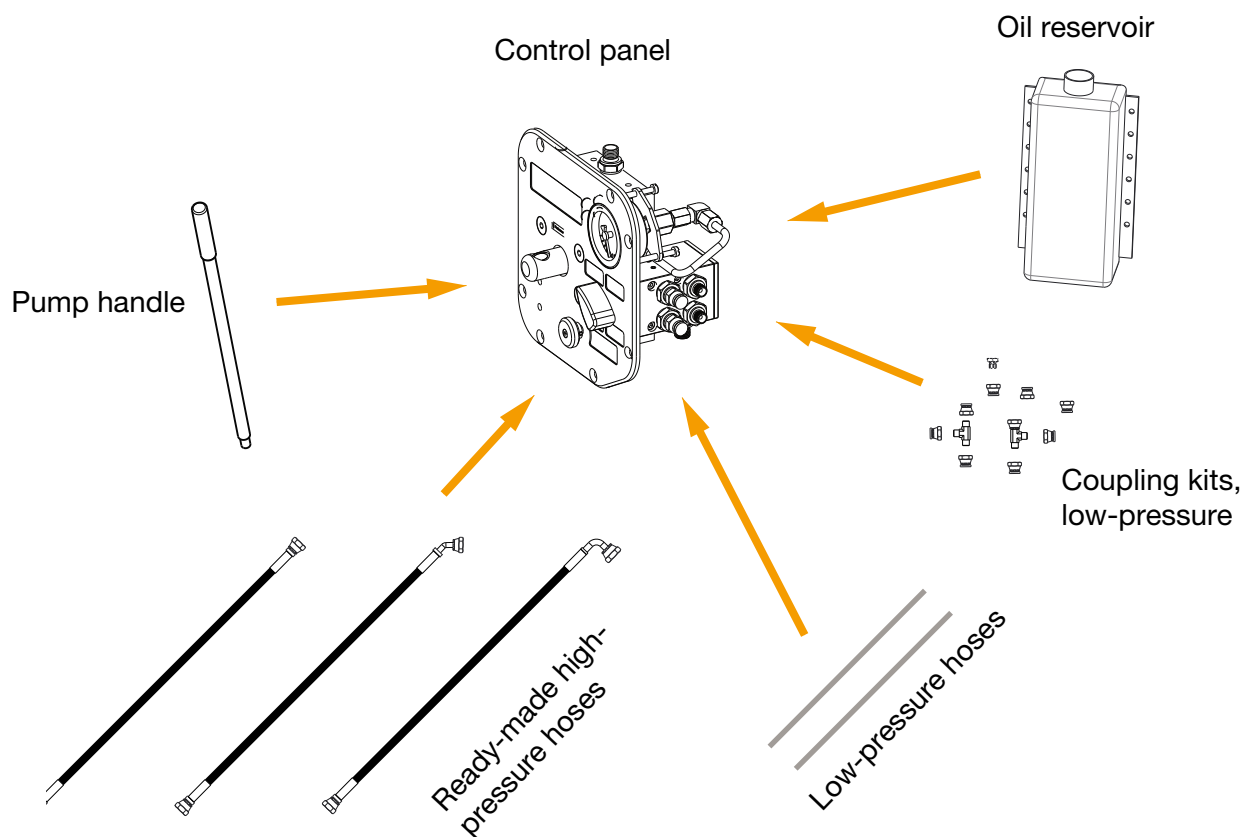



Control panel, 1-function



Control panel, 4-function

Control panels

Art. No.	Number of functions	"2-speed" function	"Dual Action" function	Anodization	Oil flow per stroke, cm ³ , low-pressure	Oil flow per stroke, cm ³ , high-pressure	Connection, low-pressure side	Connection, high-pressure side
586-503-01	1	Yes	Yes	Clear	20,1	5,6	1/4"	1/8"
586-505-01	1	Yes	Yes	Black				
586-504-04	4	Yes	Yes	Clear				
586-506-04	4	Yes	Yes	Black				

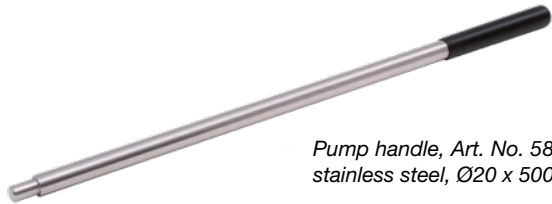

Pump handle, Art. No. 587-101
stainless steel, Ø20 x 500 mm

Oil reservoir

Art. No.	Volume, L	Male thread	For max volume of cylinders, L	Height, mm	Width, mm	Depth, mm
585-300-10	3,8	NPT 3/8"	2,3	280	220	110
585-304-10	5,7		3,4	430	220	110



Electric pump

Connects to the control panel

Art. No.	Voltage, V	Power consumption, kW	Nominal oil flow, L/min	Max working load, bar (psi)	Connection, low-pressure side	Connection, high-pressure side
587-800-01	24	0,8	1,5	250 (3600)	1/4"	1/8"
587-805-01	12	0,8	1,5	250 (3600)	1/4"	1/8"

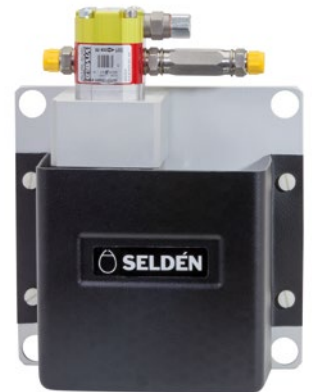

Push button

Art. No.	
540-460-05	Red
540-459-05	Green



Low-pressure hoses, made to length

To be used between the oil reservoir and the control panel.
Add suitable coupling kit.

Art. No.	Hose size	Length, mm
585-700-03	1/4"	3000
585-700-04	1/4"	4000
585-700-05	1/4"	5000
585-700-06	1/4"	6000
585-700-08	1/4"	8000
585-700-10	1/4"	10000

Low-pressure coupling kits

Art. No.	Application
585-614-25 4 hose couplings 1/4" (585-614) 2 adapters 3/8 to 1/4 male (585-638) 6 hose clamps	1 - 4 functions, 1 panel

Art. No.	Application
585-614-26 5 hose couplings 1/4" (585-614) 3 adapters 3/8 to 1/4 male (585-638) 8 hose clamps	1 - 4 functions, 1 panel with electric pump

Art. No.	Application
585-614-27 9 couplings (585-614) 2 adapters 3/8 to 1/4 male (585-638) 1 T-coupling (585-625) 12 hose clamps	1 - 4 functions, double panels

Filter

Art. No.
550-134-02

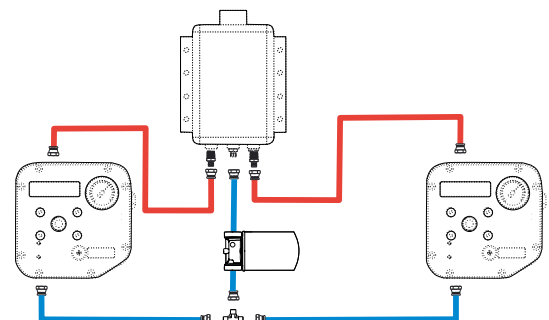
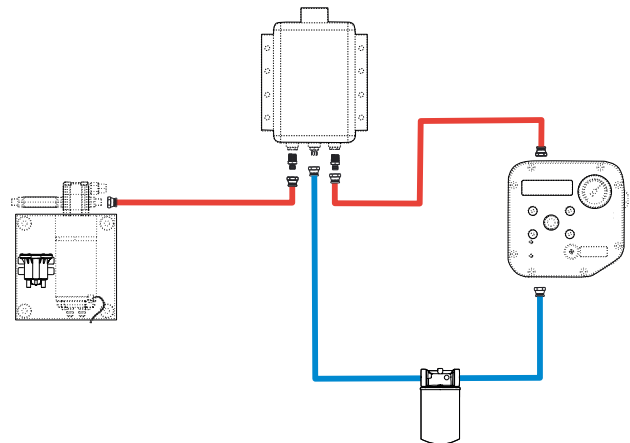
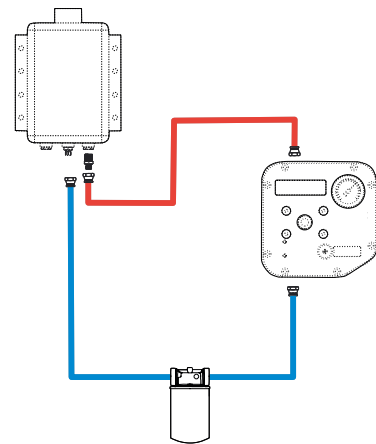
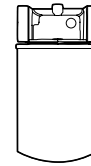

High-pressure hoses.

Made to length and complete with couplings.

To be used between control panel and cylinder. Hose size 1/4", couplings 1/8".
Max working pressure, 345 bar (5000 psi)

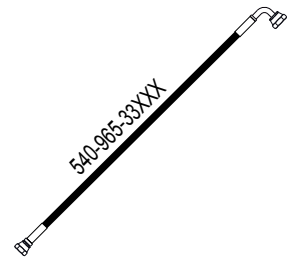
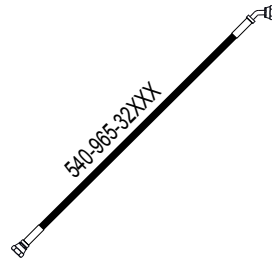
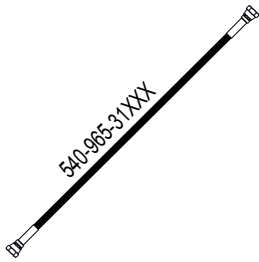

Ready-made hoses with couplings,
0/0° for backstay tensioner

Art. No.	Length (mm)
540-965-31004	400
540-965-31005	500
540-965-31006	600
540-965-31007	700
540-965-31008	800
540-965-31009	900
540-965-31010	1000
540-965-31015	1500
540-965-31020	2000
540-965-31025	2500
540-965-31030	3000
540-965-31035	3500
540-965-31040	4000
540-965-31045	4500
540-965-31050	5000
540-965-31055	5500
540-965-31060	6000
540-965-31065	6500
540-965-31070	7000
540-965-31075	7500
540-965-31080	8000
540-965-31085	8500
540-965-31090	9000
540-965-31095	9500
540-965-31100	10000

Ready-made hoses with couplings,
0/45° for halyard tensioner

Art. No.	Length (mm)
540-965-32004	400
540-965-32005	500
540-965-32006	600
540-965-32007	700
540-965-32008	800
540-965-32009	900
540-965-32010	1000
540-965-32015	1500
540-965-32020	2000
540-965-32025	2500
540-965-32030	3000
540-965-32035	3500
540-965-32040	4000
540-965-32045	4500
540-965-32050	5000
540-965-32055	5500
540-965-32060	6000
540-965-32065	6500
540-965-32070	7000
540-965-32075	7500
540-965-32080	8000
540-965-32085	8500
540-965-32090	9000
540-965-32095	9500
540-965-32100	10000

Ready-made hoses with couplings,
0/90° for hydraulic vang

Art. No.	Length (mm)
540-965-33010	1000
540-965-33015	1500
540-965-33020	2000
540-965-33025	2500
540-965-33030	3000
540-965-33035	3500
540-965-33040	4000
540-965-33045	4500
540-965-33050	5000
540-965-33055	5500
540-965-33060	6000
540-965-33065	6500
540-965-33070	7000
540-965-33075	7500
540-965-33080	8000
540-965-33085	8500
540-965-33090	9000
540-965-33095	9500
540-965-33100	10000

Electric pump, control panel
and high-pressure hoses.

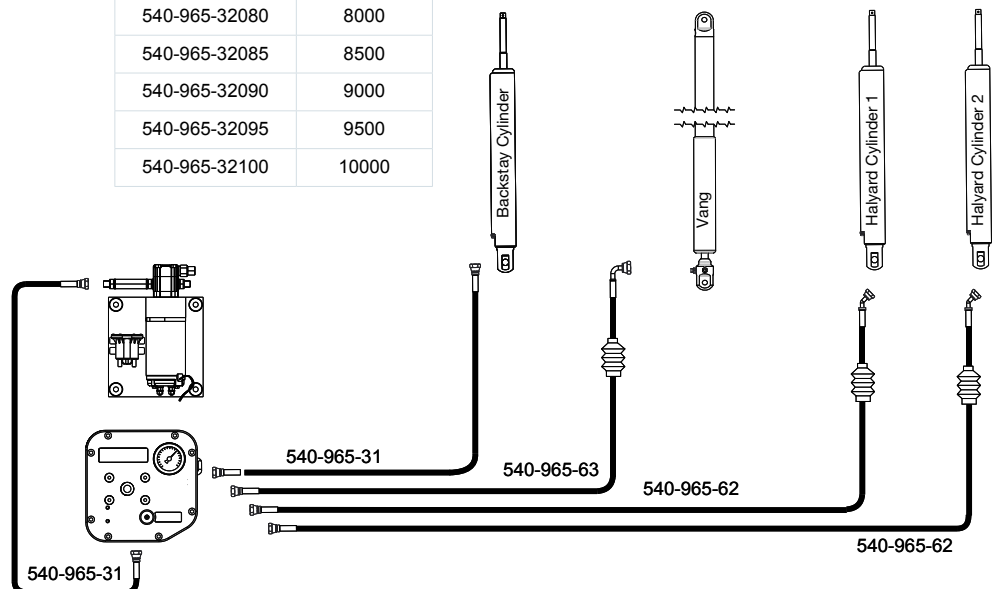

Mast-gland

Through-mast connector for outhaul cylinder.

Art. No.	Thread	Number of couplings	Max working pressure, bar (psi)
550-227-02	1/8	1	345 (5000)



Dump-valve

Pushing the button on the dump-valve releases the pressure instantly. Ideal supplement to a hydraulic vang.

Art. No.	Thread	Max working pressure, bar (psi)	Voltage, V	Connection box, Art. No.
582-006-12	1/8	345 (5000)	12	532-426-01
582-006-24	1/8	345 (5000)	24	532-426-11



Deck-glands

Through-deck connectors for halyard tensioners, vang and backstay tensioners. Clear anodized.

Art. No.	Number of couplings	Thread	Max working pressure, bar (psi)	Quick connection	Protection, stainless
540-907-11	1	1/8	345 (5000)	-	508-193 508-207
540-907-12	2	1/8	345 (5000)	-	
540-907-21	1	1/8	345 (5000)	inkluderad	
540-907-22	2	1/8	345 (5000)	inkluderad	



Art. No. 540-907-21



Art. No. 540-907-22

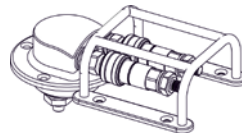

Art. No. 508-193

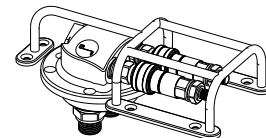

Art. No. 508-207

Quick coupling

Fitted to the 1/8" coupling on a high-pressure hose, this coupling makes for an easy and quick connection.

Art. No.	Hose dimension	Thread	Max working pressure, bar (psi)	To be used for...
585-631-01	1/4	1/4	345 (5000)	backstay tensioner, hydraulic vang





Hydraulic vang

For Seldén control panels

Art. No.	Description	Anodization	Pulling force at max working pressure, kN	Pulling force at 250 bar, electric pump	Max working pressure, bar (psi)	Max return force, kN	Stroke, mm	Min c-c pin-to-pin, mm	Lower clevis pin, ø mm	Cylinder outer dia., ø mm	Volume, L	Thread in cylinder (female)	Thread at hose connection (male)	Weight, kg
580-033-10	HV-46 Vang	Clear	44	31		8,4	280	2400	15,8	67	0,4	1/4"	1/8"	12
580-034-10		Black												
580-035-10	HV-69 Vang	Clear	57	46	345 (5000)	12	280	2650	19	79	0,7	1/4"	1/8"	15,8
580-036-10		Black												
580-036-503		Black												
580-017-501	HV-89 Vang	Clear	138	89		25	340	2300	25	110	1,2	3/8"	1/8"	27
580-018-501		Black						2790						33
580-017-01		Clear												
580-018-01		Black												

Hydraulic tensioners



Hydraulic Tensioners (HT) for Seldén control panels



Hydraulic Tensioners Integral (HTI)



- Maximum pump pressure adjustment.
- Adjustment of pressure level for downshift from high to low speed.
- Pressure release valve.



Hydraulic Tensioners (HT) for Seldén control panels

For adjustment of backstay, halyard and outhaul.

Art. No.	Description	Anodization	Max wire dia, \varnothing mm (rod size)	Pulling force at 345 bar (5000 psi), kN	Max working pressure, bar (psi)	Stroke, mm	Contracted length, mm	Lower clevis pin, \varnothing mm	Cylinder dia., \varnothing mm	Volume, L	Piston rod thread, UNF (left hand)	Thread in cylinder (female)	Thread at hose connection / male)	Weight, kg	2-speed function	Dual Action
580-003-10	HT-W8/10 Tensioner for control panel	Clear	10 (-17)	44	345 (5000)	420	826	15,8	62	0,6	5/8 – 18	1/8"	1/8"	4,3	Yes	Yes
580-004-10		Black														
580-007-10	HT-W12/14 Tensioner for control panel	Clear	14 (-40)	85	345 (5000)	480	912	22	80	1,1	7/8"	1/8"	1/8"	8	Yes	Yes
580-008-10		Black														

Hydraulic Tensioners Integral (HTI)

Art. No.	Description	Anodization	Max wire dia, \varnothing mm, (rod size)	Pulling force at 345 bar (5000 psi), kN	Max working pressure, bar (psi)	Stroke, mm	Contracted length, mm	Lower clevis pin, \varnothing mm	Cylinder dia., \varnothing mm	Piston rod thread, UNF (left hand)	Weight, kg	2-speed function	Dual Action
580-001-10	HTI-W8/10 Backstay tensioner with integral pump	Clear	10 (-17)	44	345 (5000)	420	1028	15,8	62	UNF 5/8" - 18	8,1	Yes	No
580-002-10		Black											
580-005-10	HTI-W12/14 Backstay tensioner with integral pump	Clear	14 (-40)	85	345 (5000)	480	1156	22	80	UNF 7/8" - 14	13	Yes	No
580-006-10		Black											

Upper terminals

Tensioner	Fork, stainless	Clevis pin diameter, \varnothing mm	Rigging screw body and split pin	
	Art. No.			Art. No.
HTI-W8/10 HT-W8/10	581-415-01	15,8*	5/8"	174-326-99
	581-415-01			
HTI-W12/14 HT-W12/14	581-416-01	22	7/8"	174-328-99
	581-416-02 (for -22 rod)	19		

* When W8/10 is used on a $\varnothing 7$ mm backstay with $\varnothing 13$ mm hole dia, a conversion kit with bushings and a $\varnothing 12$ mm clevis pin is required. Art. No. 306-558-04



Fork terminals, upper and lower

Art. No.	Tensioner	Clevis pin diameter, \varnothing mm	X	Y	Z	Piston rod thread, UNF (left hand)
581-415-01	HTI-W8 and HT-W8/10	15.80	16	30	19	5/8"
581-416-01	HTI-W12/14 and HT-W12/14/10	22.00	22	44	36	7/8"
581-416-02	HTI-W8 and HT-W8/10	19.00	22	44	36	7/8"

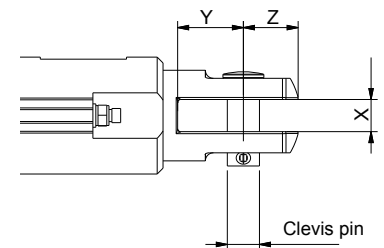

Toggle (optional)

Tensioner	Art. No.	Clevis pin diameter, \varnothing mm
HTI-W8/10 HT-W8/10	174-107-01	15,8*
HTI-W12/14 HT-W12/14	174-135-01	22
	174-134-01 (for -22 rod)	19

*If the chain plate have a $\varnothing 13$ mm hole dia, an eye/fork toggle (art. no. 174-106-01) and a conversion kit (art. no. 306-558-03) including bushings and a $\varnothing 12$ mm clevis pin are required.



Art. nr. 306-558-03/-04

Mast-jack

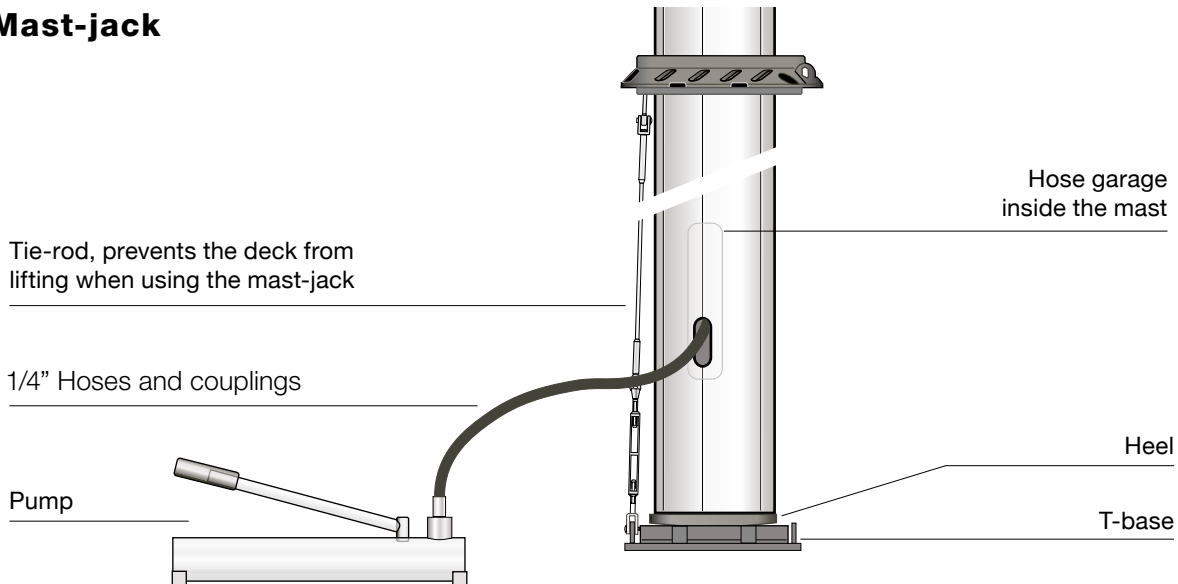

Technical specification

System	Mast extrusion	Max working pressure, bar (psi)	Max working load (kN)
D65/300	C193 CC192	300 (4350)	100
D63/400	C211-C245 CC210-CC244	400 (5800)	125
D80/500	C264-C304, F265-F305 CC263-CC303	500 (7250)	250
D110/400	C321-C405 F324-F406	450 (6525)	428

Mast-jack cylinder fitted on mast heel and 2 m hose with quick coupling (male)	Mast extrusion		Mast extrusion	
	Aluminium	Art. No.	Carbon fibre	Art. No.
	C193	502-196-01	CC192	502-196-03
	C211	502-230-01	CC210	502-230-03
	C227	502-231-01	CC226	502-231-03
	C245	502-232-01	CC244	502-232-03
	C264, F265	502-233-01	CC263	502-233-03
	C285, F286	502-234-01	CC284	502-234-03
	C304, F305	502-235-01	CC303	502-235-03
	C321, F324	502-236-01		
	C365, F370	502-237-01		
	F406	502-238-01		

Pump with manometer with quick coupling (female)	System	Art. No.
	D65/300	550-160-01
	D63/400	550-160-01
	D80/500	550-160-02
	D110/400	550-160-03

T-base with shims and U bolts for attaching tie rod	System	Art. No. (dim., mm)
	D65/300	510-208-01 (205 x 140)
	D63/400	510-180-01 (300 x 125)
	D80/500	510-185-01 (370 x 160)
	D110/400	510-190-02 (530 x 230)

Tie rod kit, includes conversion parts for standard deck ring	Mast extrusion	Art. No.
	C193, CC192	601-003-54
	C211, C227, C264, F265 CC210, CC226, CC263	508-309-02
	C245, C285, F286, C304, F308 CC244, CC284, CC303	508-309-03

Accessories	Art. No.
Hose garage, including pop rivets 	507-537-01
Shim, 2 mm (D65/300)	510-209
Shim, 5 mm (D65/300)	510-210
Shim, 10 mm (D65/300)	510-211
Shim, 2 mm (D63/400) (Tillval)	510-214
Shim, 5 mm (D63/400)	510-181
Shims, 10 mm (D63/400)	510-182
Shim, 15 mm (D63/400)	510-183
Shim, 2 mm (D80/500) (Tillval)	510-215
Shim, 5 mm (D80/500)	510-186
Shim, 10 mm (D80/500)	510-187
Shim, 20 mm (D80/500)	510-189
Locking bolts for shims (D65/300)	165-107
Locking bolts for shims (D63/400)	165-207
Locking bolts for shims (D80/500)	166-011
1/4" hydraulic hose, 2 m, with couplings	540-965-01
Quick coupling (male)	540-966
Protective plastic cover for 540-966	540-968
Quick coupling (female)	540-967
Protective plastic cover for 540-967	540-969
Sealing washer for coupling	540-885
U-bolt for securing tie rod	508-023-02
Silicon spray, 200 ml, for rubber wedges for deck ring	312-506
Safety wire with Talurit eye (Ø 5x500 mm) Some racing rules stipulate safety wire between mast and T base.	508-010-10
Shim, 5 mm (D110/400)	510-193
Shim 15 mm (D110/400)	510-194
Shim 30 mm (D110/400)	510-195

DINGHIESKEELBOATSYACHTS

Seldén Mast AB, Sweden

Tel +46 (0)31 69 69 00
e-mail info@seldenmast.com

Seldén Mast Limited, UK

Tel +44 (0)1329 50 40 00
e-mail info@seldenmast.co.uk

Seldén Mast Inc., USA

Tel +1 843-760-6278
e-mail info@seldenus.com

Seldén Mast A/S, Denmark

Tel +45 39 18 44 00
e-mail info@seldenmast.dk

**Seldén Mid Europe B.V.,
Netherlands**

Tel +31 (0)111-698 120
e-mail info@seldenmast.nl

Seldén Mast SAS, France

Tel +33 (0)251 362 110
e-mail info@seldenmast.fr

www.seldenmast.com

The Seldén Group is the world's leading manufacturer of mast and rigging systems in carbon and aluminium for dinghies, keelboats and yachts.

Our well known brands are Seldén and Furlex. The worldwide success of Furlex has enabled us to build a network of over 750 authorised dealers covering the world's marine markets. So wherever you sail, you can be sure of fast access to our service, spare parts and know-how.

Seldén and Furlex are registered trademarks of Seldén Mast AB.

